

SINAMICS G120D

Distributed inverters

0.75 kW to 7.5 kW (1.0 hp to 10 hp)

6



6/2	SINAMICS G120D distributed inverters
6/2	Overview
6/3	Benefits
6/4	Applications
6/4	Design
6/5	Configuration
6/6	Technical specifications
6/7	CU240D Control Units
6/7	Overview
6/7	Selection and ordering data
6/8	Design
6/9	Integration
6/11	Technical specifications
6/13	PM250D Power Modules
6/13	Overview
6/13	Selection and ordering data
6/14	Integration
6/15	Technical specifications
6/18	Characteristic curves
6/19	Dimensional drawings
6/20	Recommended line components
6/20	Overview
6/20	Selection and ordering data
6/21	Supplementary system components
6/21	Intelligent Operator Panel IOP Handheld
6/22	MMC memory card
6/22	RS232 interface cable for communication with a PC
6/22	USB interface cable for communication with a PC
6/22	STARTER commissioning tool
6/23	PROFINET connecting cable
6/23	PROFIBUS connecting cable
6/23	Connecting cables/connectors for supplying the Control Unit with power
6/23	Connecting cables for digital inputs
6/24	Connecting cables pre-fabricated at one end and connector sets to connect to the line supply
6/24	Motor cables pre-fabricated at one end and connector sets to connect the Power Module to the motor
6/25	Power bus distribution 400 V in IP65 degree of protection
6/25	Additional information
6/26	Spare parts
6/26	Spare Parts Kit
6/26	Replacement fan

SINAMICS G120D

Distributed inverters 0.75 kW to 7.5 kW (1.0 hp to 10 hp)

SINAMICS G120D distributed inverters

Overview

The new SINAMICS G120D distributed frequency inverter series is the solution for demanding drive tasks especially in the field of conveyor systems. SINAMICS G120D inverters continuously control the speed of three-phase asynchronous motors and fulfill all the requirements of conveyor system applications from simple frequency control through to demanding vector control. With its well-thought-out modular design with IP65 degree of protection, it can be seamlessly integrated into the plant or system and supports a high plant availability and low stocks of spare parts. The innovative power unit concept capable of energy recovery helps to save energy. Safety functions that are unique worldwide permit improved plant and system concepts with a higher productivity. This drive can be optimally integrated into the Siemens TIA world of automation via PROFIBUS or PROFINET.

With different device versions (frame sizes FSA to FSC) in a power range from 0.75 kW to 7.5 kW (1.0 hp to 10 hp), it is suitable for a wide variety of drive solutions.



Example: SINAMICS G120D, frame size FSA, comprising PM250D Power Module and Fail-safe CU240D DP-F Control Unit

Reasons for using distributed drive systems

- Modular drive solutions – therefore standardized mechatronic elements that can be individually tested
- A control cabinet is not required, resulting in a smaller space requirement and lower cooling requirements
- Long cables between the inverter and motor can be avoided (which means lower power losses, reduced noise emission and lower costs for shielded cables and additional filters)
- Distributed configurations offer considerable benefits for conveyor systems with their extensive coverage (e.g. in the automotive and logistics sectors)

Siemens family of distributed drives

Siemens offers an innovative portfolio of frequency inverters to optimally implement distributed drive solutions. The strengths of the individual members of the drive family permit simple adaptation to the widest range of application demands:

- Identical connection systems
- Identical mounting dimensions for SINAMICS G110D and SINAMICS G120D
- Standard commissioning and configuration tool

Products from the family of distributed drives:

- SINAMICS G110D frequency inverters
- SINAMICS G120D frequency inverters
- SIMATIC ET 200S FC drive converters
- SIMATIC ET 200pro FC drive converters
- SIRIUS M200D motor starters

Modularity

SINAMICS G120D is a modular inverter system with IP65 degree of protection comprising various function units. The main units are:

- Control Unit (CU)
- Power Module (PM)

The Control Unit controls and monitors the Power Module and the connected motor using several different closed-loop control types that can be selected. The digital inputs and digital outputs on the device support the simple wiring of sensors and actuators directly at the drive. The input signals can either be directly linked within the Control Unit and initiate local responses independently or they can be transferred to the central control via PROFIBUS or PROFINET for processing within the context of the overall plant.

The Power Module supplies the motor in a power range 0.75 kW to 7.5 kW (1.0 hp to 10 hp). The Power Module is controlled by a microprocessor in the Control Unit. State-of-the-art IGBT technology with pulse-width-modulation is used for highly reliable and flexible motor operation. Comprehensive protection functions provide a high degree of protection for the Power Module and the motor. The unusually low profile mechanical design is optimized so that the device can be directly used in the plant or system. The Power Module also has the same drilling dimensions for all power ratings (one standard footprint). Further, the dimensions are identical to those of SINAMICS G110D. This significantly simplifies the mechanical design, installation and retrofit of a system.

The latest technical documentation (catalogs, dimensional drawings, certificates, manuals and operating instructions), are available on the Internet under:

<http://www.siemens.com/sinamics-g120d/documentation>

and offline on the DVD CA 01 in the SD Configurator. In addition, the SD Configurator can be used on the Internet without requiring any installation. The SD Configurator can be found in the Siemens Mall under the following address:

<http://www.siemens.com/dt-configurator>

Distributed inverters 0.75 kW to 7.5 kW (1.0 hp to 10 hp)

SINAMICS G120D distributed inverters

Overview**Safety Integrated**

The SINAMICS G120D distributed inverters include versions for safety-oriented applications. All Power Modules are already designed for Safety Integrated. A Safety Integrated Drive can be created by combining a Power Module with the relevant Fail-safe Control Unit.

SINAMICS G120D fail-safe inverter provides three safety functions, certified in accordance with EN 954-1, Category 3 and IEC 61508 SIL 2:

- Safe Torque Off (STO) to protect against active movement of the drive
- Safe Stop 1 (SS1) for continuous monitoring of a safe braking ramp
- Safely Limited Speed (SLS) for protection against dangerous movements when a speed limit is exceeded

The functions "Safe Stop 1" and "Safely Limited Speed" can both be implemented without having to use a motor encoder or encoder; the implementation cost is minimal. Existing systems in particular can be updated with safety technology without the need to change the motor or mechanical system.

The safety functions "Safely Limited Speed" and "Safe Stop 1" are not certified for pull-through loads such as e.g. hoisting gear and unwinders.

Additional information is provided in the part Highlights, section Safety Integrated.

Efficient Infeed Technology

The advanced Efficient Infeed Technology is employed in PM250D Power Modules. This technology allows the energy produced by motors operating in generator mode connected to standard inverters to be fed back into the supply system. At the same time, considerable savings can be achieved in terms of energy consumption and operating costs.

Additional information is included in the part Highlights, section Efficient Infeed Technology.

STARTER commissioning tool

The STARTER commissioning tool (from STARTER Version 4.1, SP1 and higher) supports the commissioning and maintenance of SINAMICS G120D inverters. The operator guidance combined with comprehensive, user-friendly functions for the relevant drive solution allow you to commission the device quickly and easily.

Benefits

- Mechanical design, installation and retrofit of a system are significantly simplified as a result of the compact and space-saving design with an extremely low profile and with the same drilling dimensions for all power ratings; further, the dimensions are identical with those of the SINAMICS G110D
- Wide power range from 0.75 kW to 7.5 kW (1.0 hp to 10 hp)
- The safety functions make it easier to integrate drives into safety-oriented machines or plants
- The innovative circuit design (bidirectional input rectifier with "pared-down" DC link) allows the kinetic energy of a load to be fed back into the line supply system. This feedback capability provides enormous potential for energy savings because generated energy no longer has to be converted into heat in a braking resistor. Braking resistors and reactors are not necessary – this is a particular advantage in terms of the space requirement and installation costs for the high IP65 degree of protection
- Simple commissioning and maintenance as a result of the same, standard plug-in connections of the bus, power and I/O connections (ISO 23570) for the complete range of power ratings of SINAMICS G110D and SINAMICS G120D

- Increased degree of ruggedness and longer service life as the electronic modules are coated
- Flexibility due to modularity for a future-oriented distributed drive concept with a high IP65 degree of protection
 - Module replacement under voltage (hot swapping)
 - The modules can be easily replaced, which makes the system extremely service friendly
- Simple, standard implementation of completely distributed plant and system concepts by using products in a scalable fashion:
 - SIRIUS M200D (motor starter)
 - SINAMICS G110D (inverter for basic, conveyor-related applications)
 - SINAMICS G120D (inverter for sophisticated, conveyor-related applications)
- The same connectors are used as for the SIRIUS M200D motor starter
- Communications-capable via PROFINET or PROFIBUS with PROFDIdrive Profile 4.0
 - Reduced number of interfaces
 - Plantwide engineering
 - Easy to handle
- Simple connection, configuration, data management as well as control of the inverter in complex plants and systems as a result of the consequential integration in TIA (Totally Integrated Automation)
- High degree of operator friendliness by using the Intelligent Operator Panel (IOP) to parameterize, diagnose, control (open-loop) and copy drive parameters in the IOP
- The ability to connect up to six sensors and two actuators directly to the Control Unit means that almost all of the drive information can be directly managed; local preprocessing of the signals takes the load off the fieldbus and ensures a fast and reproducible response time
- Integrated class A EMC filter (acc. to EN 55011)
- Integrated brake control, brake voltages that are supported, 400 V AC / 180 V DC
- Integrated motor protection using a thermal motor model and evaluation of PTC, Thermo-Click or KTY 84 temperature sensors
- Software parameters for simple adaptation to 50 Hz or 60 Hz motors (IEC or NEMA motors)
- Easy replacement of devices and fast copying of parameters to the memory card using the optional MMC memory card
- Engineering and commissioning with standard engineering tools such as SIZER (from Version 2.9 and higher), STARTER (from Version 4.1, SP1 and higher) and Drive ES: Ensure fast engineering and easy commissioning – STARTER is integrated in STEP 7 with Drive ES Basic with all the advantages of central data storage and totally integrated communication
- Certified worldwide for compliance with CE, UL, cUL, C-tick and Safety Integrated according to EN 954-1, Category 3 and IEC 61508 SIL 2

SINAMICS G120D

Distributed inverters 0.75 kW to 7.5 kW (1.0 hp to 10 hp)

SINAMICS G120D distributed inverters

Applications

SINAMICS G120D is ideally suited to demanding conveyor system applications in the industrial environment for which a distributed drive with communications capability is required. This applies in particular to the automotive sector, e.g. assembly lines.

SINAMICS G120D is also suitable for additional high-performance applications, e.g. in the airport sector, food and beverage industry (without tenside) and in distribution logistics (e.g. electric monorail systems).

Design

The SINAMICS G120D distributed frequency inverters are modular inverters for standard drives. Each SINAMICS G120D comprises two operative units – the Power Module and Control Unit.

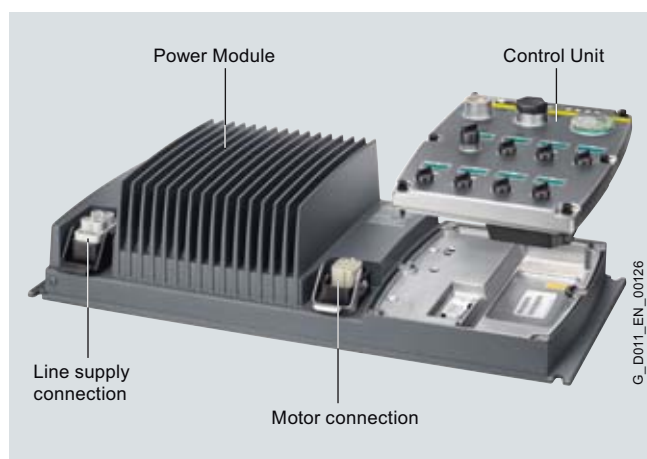

Power Module PM250D with line and motor connections and CU240D Control Unit

Power Modules

The following Power Modules are available for the SINAMICS G120D distributed inverters:

PM250D Power Modules

PM250D Power Modules (0.75 kW to 7.5 kW/1.0 hp to 10 hp) have an innovative circuit design which allows line-commutated energy recovery back into the line supply. This innovative circuit permits generated energy to be fed back into the supply system and therefore saves energy.

Control Units

The following Control Units are available for SINAMICS G120D distributed inverters:

CU240D Control Units

The Control Unit performs closed-loop control functions for the inverter. In addition to the closed-loop control, it has additional functions that can be adapted to the particular application through parameterization. Several Control Units are available in different versions:

- CU240D DP
- CU240D DP-F
- CU240D PN
- CU240D PN-F

Supplementary System Components

Intelligent Operator Panel IOP Handheld

The IOP supports both entry-level personnel and drive experts. Thanks to the large plain text display, the menu prompting and the Application Wizards, it is easy to commission, diagnose and locally control standard drives.

MMC memory card

The parameter settings for an inverter can be stored on the MMC memory card. When service is required, e.g. after the inverter has been replaced and the data have been downloaded from the memory card the drive system is immediately ready for use again. The associated slot is located on the rear of the Control Unit.

RS232 interface cable for communication with a PC

For controlling and commissioning an inverter directly from a PC if the appropriate software (STARTER commissioning tool from Version 4.1, SP1 and higher) has been installed.

USB interface cable for communication with a PC

For controlling and commissioning an inverter directly from a PC if the appropriate software (STARTER commissioning tool from Version 4.1.3 and higher) has been installed.

Connecting cable for the Control Units

Flexible plug-in cables to transfer data between the Industrial Ethernet participants or PROFIBUS participants, as well as to supply power to the Control Unit.

Connecting cable for the Power Modules

Connector sets to connect to the line supply and the outgoing motor feeder are available as accessories as well as pre-fabricated motor cables for connection to the motor.

Spare Parts Kit

A Spare Parts Kit is available which comprises small parts such as seals, caps, PROFIBUS address windows and screws.

Replacement fan

A replacement fan is available, which comprises a pre-mounted unit with cover, fan and screws.

SINAMICS G120D

Distributed inverters 0.75 kW to 7.5 kW (1.0 hp to 10 hp)

SINAMICS G120D distributed inverters

Configuration

The following electronic configuring aids and engineering tools are available for the SINAMICS G120D distributed inverters:

Selection guide, SD Configurator within the CA 01

More than 100,000 products with approximately 5 million possible product versions from the area of drive technology are listed in the Interactive Catalog CA 01 – the Offline Mall from Siemens IA&DT. In order to make it easier to select the optimum motor and/or inverter from the wide range of Standard Drives, the SD Configurator was developed, which is integrated as “Selection guide” in this catalog on the DVD with the selection and configuration tools.

Online SD Configurator

In addition, the SD Configurator can now be used on the Internet without requiring any installation. The SD Configurator can be found in the Siemens Mall under the following address:

<http://www.siemens.com/dt-configurator>

SIZER Configuration Tool

The SIZER PC tool makes it easy to engineer the SINAMICS and MICROMASTER 4 drive family. It provides support when selecting the hardware and firmware components necessary to implement a drive task. SIZER supports the configuration of the complete drive system and allows simple single-motor drives up to complex multi-axis applications to be engineered. For SINAMICS G120D from SIZER Version 2.9 and higher.

STARTER Commissioning Tool

The STARTER commissioning tool allows menu-prompted commissioning, optimization and diagnostics. In addition to SINAMICS drives, STARTER is also suitable for MICROMASTER 4 units and the drive converters for the distributed I/O SIMATIC ET 200S FC and SIMATIC ET 200pro FC. For SINAMICS G120D from STARTER Version 4.1, SP1 and higher.

Drive ES Engineering System

Drive ES is the engineering system used to integrate the communication, configuration and data management functions of Siemens drive technology into the SIMATIC automation world easily, efficiently and cost-effectively. The STEP 7 Manager user interface forms the basis. A variety of software packages, i.e. Drive ES Basic, Drive ES SIMATIC and Drive ES PCS 7, are available for SINAMICS.

SINAMICS G120D

Distributed inverters 0.75 kW to 7.5 kW (1.0 hp to 10 hp)

SINAMICS G120D distributed inverters

Technical specifications

Unless explicitly specified otherwise, the following technical specifications are valid for all the following components of the SINAMICS G120D distributed inverter listed here.

SINAMICS G120D	
Mechanical specifications	
Vibratory load according to EN 60068-2-6	
• Transport ¹⁾	5 ... 9 Hz: Constant deflection, 3.1 mm 9 ... 200 Hz: Constant acceleration = 9.81 m/s ² (1 × g)
• Operation	10 ... 58 Hz: Constant deflection, 0.15 mm 58 ... 200 Hz: Constant acceleration = 19.62 m/s ² (2 × g)
Shock load according to EN 60068-2-27	
• Transport ¹⁾	147.15 m/s ² (15 × g)/11 ms 3 Shocks in each axis and direction
• Operation	147.15 m/s ² (15 × g)/11 ms 3 Shocks in each axis and direction
Ambient conditions	
Protection class acc. to EN 61800-5-1	Class III (PELV)
Touch protection according to EN 61800-5-1	Class I (with protective conductor system)
Permissible ambient and coolant temperature (air) during operation for Power Modules	-10 ... +40 °C without derating > 40 ... 55 °C see derating characteristics
Permissible ambient and coolant temperature (air) during operation for Control Units	CU240D DP: -10 ... +55 °C CU240D PN: -10 ... +50 °C CU240D DP-F: 0 ... 55 °C CU240D PN-F: 0 ... 50 °C (> 40 ... 55 °C see derating characteristics) up to 2000 m above sea level
Climatic ambient conditions	
• Storage ¹⁾ acc. to EN 60068-2-1	Temperature -40 ... +70 °C
• Transport ¹⁾ acc. to EN 60068-2-1	Temperature -40 ... +70 °C max. humidity 95 % at 40 °C
• Operation acc. to EN 60068-2-2	Temperature -10 ... +40 °C without derating
Environmental class/harmful chemical substances	
• Operation acc. to EN 60721-3-3	Class 3C2
Degree of pollution acc. to EN 61800-5-1	2
Certification for Fail-safe versions	
• Category acc. to EN 954-1	3
• SIL Cl acc. to IEC 61508	2
• PL acc. to ISO 13849	Available soon
• PFH _D	5 × 10 ⁻⁸
• T1	10 Years
Standards	
Compliance with standards	UL 508C (UL list number E121068), CE, c-tick
CE mark	According to Low-Voltage Directive 73/23/EEC and Machinery Directive 98/37/EC
EMC Directive ²⁾	
• Frame sizes FSA to FSC with integrated class A line filter	Category C2 ³⁾ acc. to EN 61800-3 (corresponds to class A acc. to EN 55011)

Note: The EMC product standard EN 61800-3 does not apply directly to a frequency inverter but to a PDS (Power Drive System), which comprises the complete circuitry, motor and cables in addition to the inverter. The frequency inverters on their own do not generally require identification according to the EMC Directive.

¹⁾ In transport packaging.

²⁾ For further general information, see also SINAMICS G110 section Technical specifications, Compliance with standards.

³⁾ With shielded motor cable up to 15 m.

Overview



Example of CU240D DP-F Control Unit



Example of CU240D PN-F Control Unit

The Control Unit performs closed-loop control functions for the inverter. In addition to the closed-loop control, it has additional functions that can be adapted to the particular application through parameterization. Control Units are available in different versions:

- CU240D DP
- CU240D DP-F
- CU240D PN
- CU240D PN-F

Safety Integrated functions

The SINAMICS G120D fail-safe inverter provides three safety functions, certified in accordance with EN 954-1, Category 3 and IEC 61508 SIL 2:

- Safe Torque Off (STO) to protect against active movement of the drive
- Safe Stop 1 (SS1) for continuous monitoring of a safe braking ramp
- Safely Limited Speed (SLS) for protection against dangerous movements when a speed limit is exceeded

The functions "Safe Stop 1" and "Safely Limited Speed" can both be implemented without a motor encoder or encoder; the implementation cost is minimal. Existing systems in particular can be simply updated with safety technology without the need to change the motor or mechanical system.

The safety functions "Safely Limited Speed" and "Safe Stop 1" are not permitted for pull-through loads such as e.g. hoisting gear and unwinders.

Safety functions have been extended with firmware V3.2.

Additional information is provided in the part Highlights, section Safety Integrated.

Selection and ordering data

Communication	Digital inputs	Digital outputs	Encoder interfaces	Designation	Control Unit Order No.
Standard					
PROFIBUS DP	6	2	1	CU240D DP	6SL3544-0FA20-1PA0
PROFINET	6	2	1	CU240D PN	6SL3544-0FA20-1FA0
Fail-safe for Safety Integrated					
PROFIBUS DP	6	2	1	CU240D DP-F	6SL3544-0FA21-1PA0
PROFINET	6	2	1	CU240D PN-F	6SL3544-0FA21-1FA0

SINAMICS G120D

Distributed inverters 0.75 kW to 7.5 kW (1.0 hp to 10 hp)

CU240D Control Units

Design

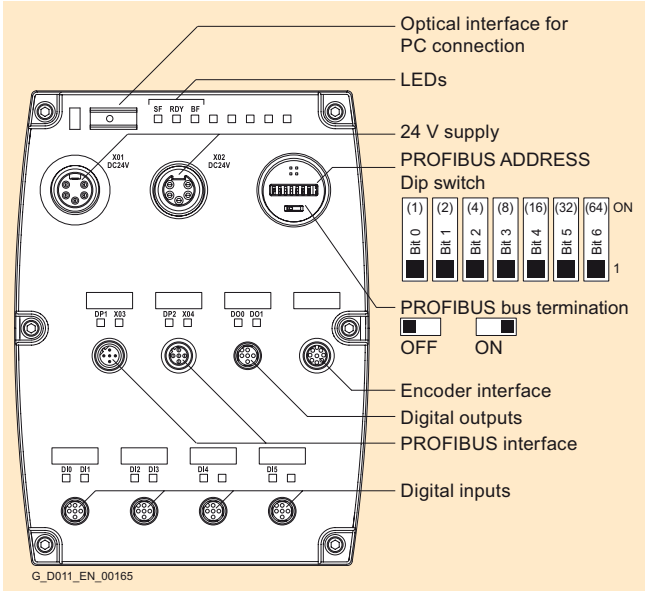

CU240D DP Control Unit

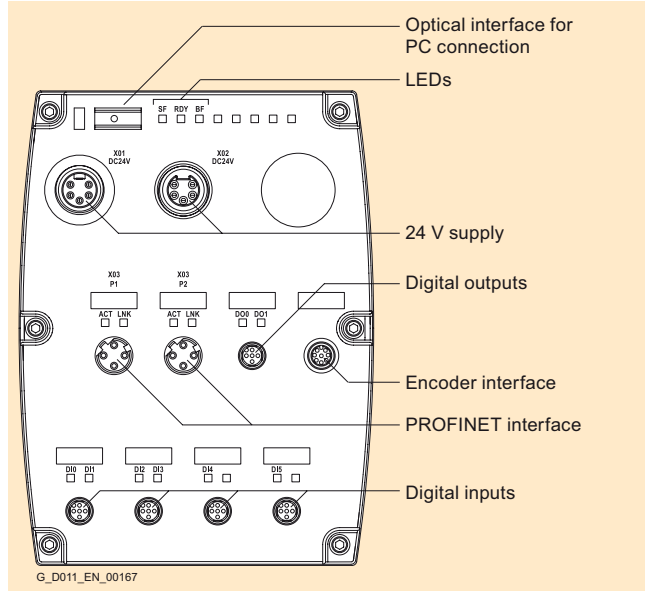

CU240D PN Control Unit

6

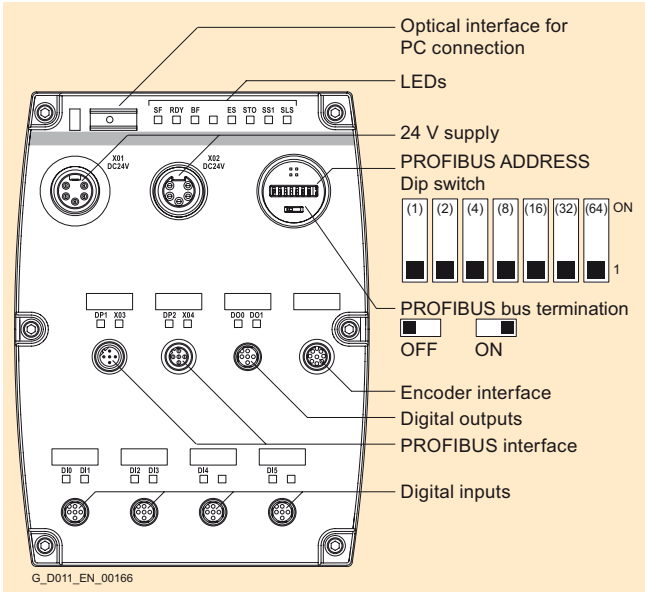

CU240D DP-F Control Unit

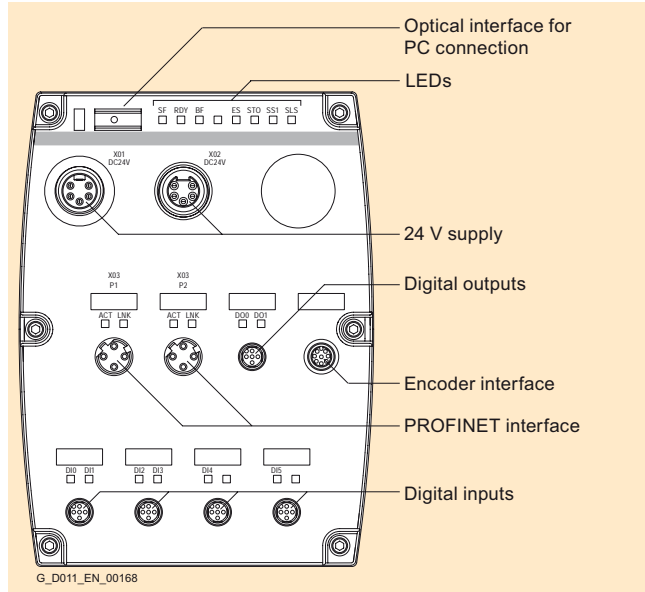

CU240D PN-F Control Unit



Control Unit, view from the rear, MMC slot at the top and PM-IF interface at bottom center

Integration

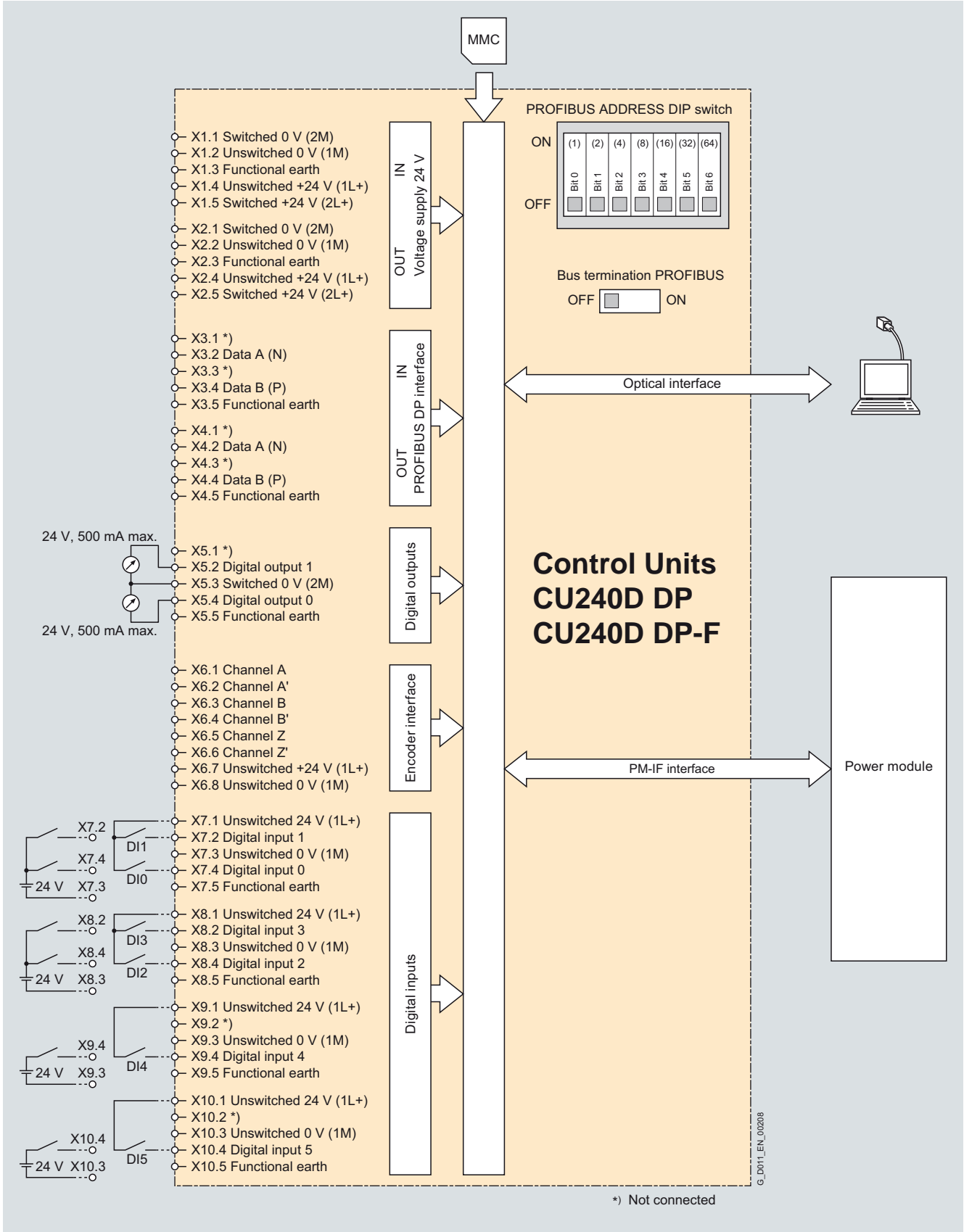

Connection diagram for CU240D DP and CU240D DP-F Control Units

SINAMICS G120D

Distributed inverters 0.75 kW to 7.5 kW (1.0 hp to 10 hp)

CU240D Control Units

Integration

6

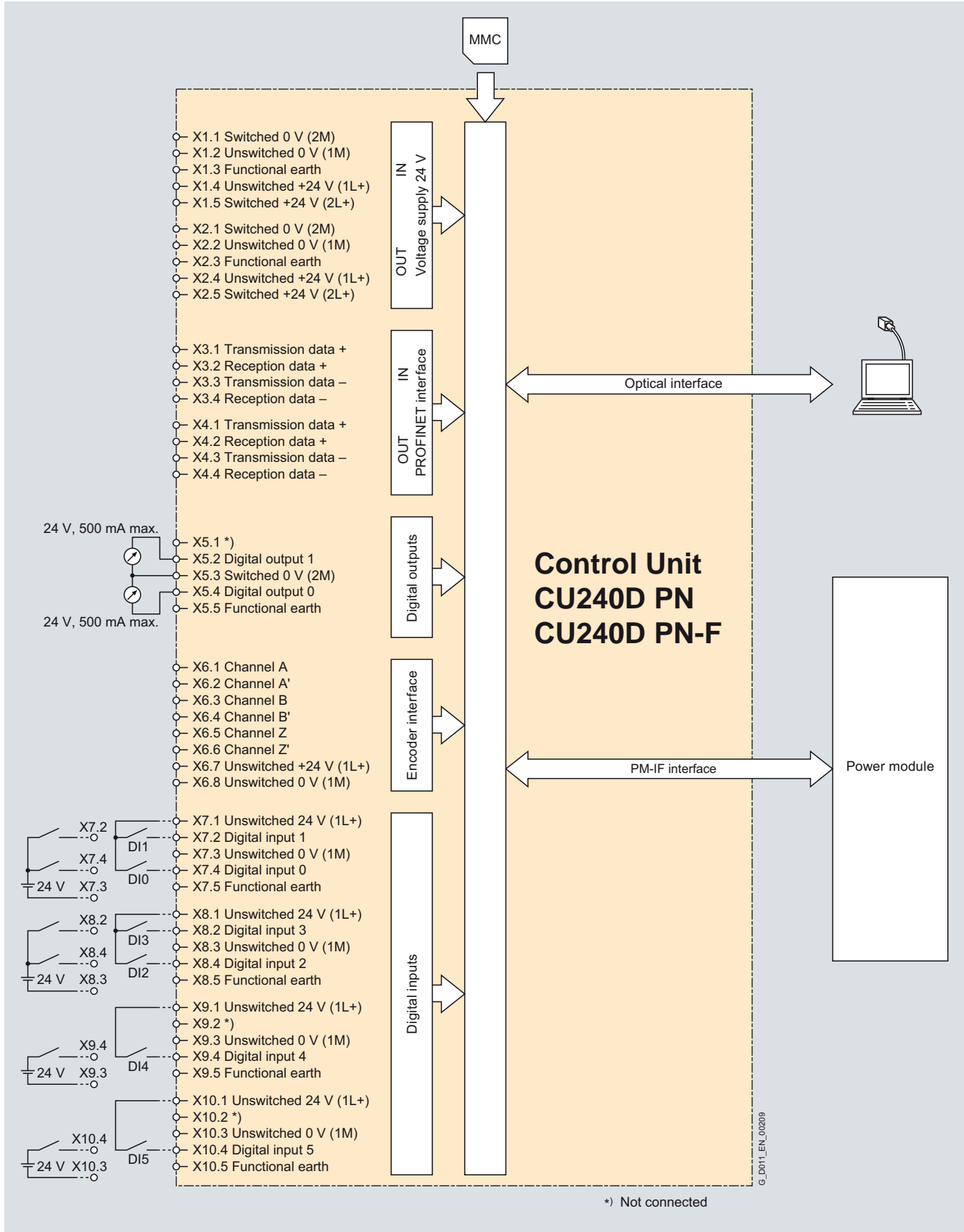

Connection diagram for CU240D PN and CU240D PN-F Control Units

Technical specifications

Control Unit	CU240D DP 6SL3544-0FA20-1PA0	CU240D PN 6SL3544-0FA20-1FA0	CU240D DP-F 6SL3544-0FA21-1PA0	CU240D PN-F 6SL3544-0FA21-1FA0
Electrical specifications				
Operating voltage	external 24 V DC necessary	external 24 V DC necessary	external 24 V DC necessary	external 24 V DC necessary
Current consumption ¹⁾ (from the 24 V supply)				
• with Power Module frame sizes FSA and FSB	200 mA	350 mA	200 mA	350 mA
• with Power Module frame size FSC	350 mA	500 mA	350 mA	500 mA
Interfaces				
Digital inputs	6	6	6	6
Digital outputs (0.5 A, fed through switched 24 V DC)	2	2	2	2
Bus interface	PROFIBUS DP	PROFINET	PROFIBUS DP, PROFIsafe	PROFINET, PROFIsafe
Encoder interfaces (HTL incremental interface, bipolar up to 2048 pulses, max. 100 mA)	1	1	1	1
PTC/KTY interface (connection via Power Module)	✓	✓	✓	✓
• Motor temperature sensor	1 input, sensors that can be connected: PTC, KTY or Thermo-Click	1 input, sensors that can be connected: PTC, KTY or Thermo-Click	1 input, sensors that can be connected: PTC, KTY or Thermo-Click	1 input, sensors that can be connected: PTC, KTY or Thermo-Click
Control of a mechanical motor brake (connection via Power Module)	✓	✓	✓	✓
MMC memory card slot	✓	✓	✓	✓
RS232 interface (connected with RS232 interface cable or USB interface cable via the optical interface of the Control Unit)	✓	✓	✓	✓
Safety functions				
Integrated safety functions Acc. to Category 3 of EN 954-1 and acc. to SIL 2 of IEC 61508	–		<ul style="list-style-type: none"> • Safe Stop 1 (SS1) • Safely Limited Speed (SLS) • Safe Torque Off (STO) • The safety functions "Safely Limited Speed" and "Safe Stop 1" are not certified for pull-through loads such as e.g. hoisting gear and unwinders. 	<ul style="list-style-type: none"> • Safe Stop 1 (SS1) • Safely Limited Speed (SLS) • Safe Torque Off (STO) • The safety functions "Safely Limited Speed" and "Safe Stop 1" are not certified for pull-through loads such as e.g. hoisting gear and unwinders.
Open-loop/closed-loop control techniques				
V/f linear/square/parameterizable	✓	✓	✓	✓
V/f with flux current control (FCC)	✓	✓	✓	✓
Vector control, without encoder	✓	✓	✓	✓
Vector control, with encoder	✓	✓	✓	✓
Torque control, without encoder	✓	✓	✓	✓
Torque control, with encoder	✓	✓	✓	✓

¹⁾ The current consumption of connected encoders and sensors (total, max. 300 mA) as well as the current drawn from the digital outputs must be added.

SINAMICS G120D

Distributed inverters 0.75 kW to 7.5 kW (1.0 hp to 10 hp)

CU240D Control Units

Technical specifications

Control Unit	CU240D DP 6SL3544-0FA20-1PA0	CU240D PN 6SL3544-0FA20-1FA0	CU240D DP-F 6SL3544-0FA21-1PA0	CU240D PN-F 6SL3544-0FA21-1FA0
Software functions				
Fixed frequencies	16, parameterizable	16, parameterizable	16, parameterizable	16, parameterizable
Signal interconnection with BICO technology	✓	✓	✓	✓
Automatic restart after line supply failure or operational fault	✓	✓	✓	✓
Positioning down ramp	✓	✓	✓	✓
Slip compensation	✓	✓	✓	✓
Free function blocks (FFB) for logic and arithmetic operations	✓	✓	✓	✓
Ramp smoothing	✓	✓	✓	✓
3 selectable drive data sets	✓	✓	✓	✓
3 selectable command data sets (CDS) (manual/auto)	✓	✓	✓	✓
Flying restart	✓	✓	✓	✓
JOG	✓	✓	✓	✓
Technology controller (PID)	✓	✓	✓	✓
Thermal motor protection	✓	✓	✓	✓
Thermal inverter protection	✓	✓	✓	✓
Setpoint input	✓	✓	✓	✓
Motor identification	✓	✓	✓	✓
Motor holding brake	✓	✓	✓	✓
Mechanical specifications and ambient conditions				
Degree of protection	IP65	IP65	IP65	IP65
Operating temperature	-10 ... +55 °C (14 ... 131 °F)	-10 ... +50 °C (14 ... 122 °F)	0 ... 55 °C (32 ... 131 °F)	0 ... 50 °C (32 ... 122 °F)
Storage temperature	-40 ... +70 °C (-40 ... +158 °F)	-40 ... +70 °C (-40 ... +158 °F)	-40 ... +70 °C (-40 ... +158 °F)	-40 ... +70 °C (-40 ... +158 °F)
Relative humidity	< 95 % RH, condensation not permissible	< 95 % RH, condensation not permissible	< 95 % RH, condensation not permissible	< 95 % RH, condensation not permissible
Dimensions				
• Width	150 mm	150 mm	150 mm	150 mm
• Height	210 mm	210 mm	210 mm	210 mm
• Depth	40 mm	40 mm	40 mm	40 mm
Weight, approx.	0.7 kg	0.7 kg	0.7 kg	0.7 kg

Overview

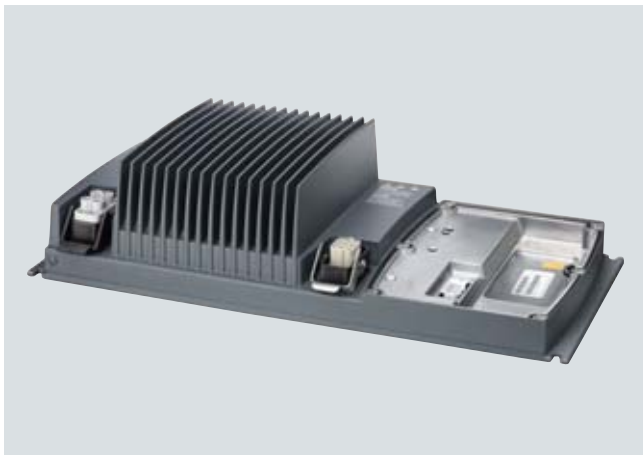

Example of PM250D Power Module frame size FSA

The regenerative feedback capability of the PM250D Power Module in generator mode (electronic braking) means that energy is returned to the supply system and is not wasted in a braking resistor. This saves space, time-consuming dimensioning of the braking resistor as well as its wiring. The amount of generated heat is also reduced. For further information, please refer to part Innovation, section Efficient Infeed Technology.

An innovative circuit design reduces the line harmonics. A line reactor is not required. This saves space and costs for configuration and procurement.

The PM250D Power Module is also designed for safety-oriented applications. In conjunction with a Fail-safe Control Unit, the drive can be turned into a Safety Integrated Drive (see Control Units).

The PM250D Power Modules with integrated class A line filter are suitable for connection to TN and TT supply systems.

Selection and ordering data

Rated power ¹⁾		Rated output current ²⁾	Input current	Frame size	SINAMICS G120D PM250D Power Module with integrated class A line filter
kW	hp	A	A		Order No.
380 ... 500 V 3 AC					
0.75	1	2.2	2.1	FSA	6SL3525-0PE17-5AA0
1.5	1.5 ³⁾	4.1	3.8	FSA	6SL3525-0PE21-5AA0
3	4	7.7	7.2	FSB	6SL3525-0PE23-0AA0
4	5	10.2	9.5	FSC	6SL3525-0PE24-0AA0
5.5	7.5	13.2	12.2	FSC	6SL3525-0PE25-5AA0
7.5	10	19.0	17.7	FSC	6SL3525-0PE27-5AA0

¹⁾ Rated power based on the rated output current I_{rated} . The rated output current I_{rated} is based on the duty cycle for high overload (HO).

²⁾ The rated output current I_{rated} is based on the duty cycle for high overload (HO). These current values are valid for 400 V and are stamped on the rating plate of the Power Module.

³⁾ It is not possible to make any assignment to a particular standard.

SINAMICS G120D

Distributed inverters 0.75 kW to 7.5 kW (1.0 hp to 10 hp)

PM250D Power Modules

Integration

PM250D Power Modules communicate with the Control Unit via the PM-IF interface.

PM250D Power Modules have the following interfaces as standard:

- PM-IF interface to connect the PM250D Power Module to the Control Unit.
- Motor connection via a HAN Q8 (connector) including control of the motor brake and temperature sensor
- Line supply connection via HAN Q4/2 (socket)

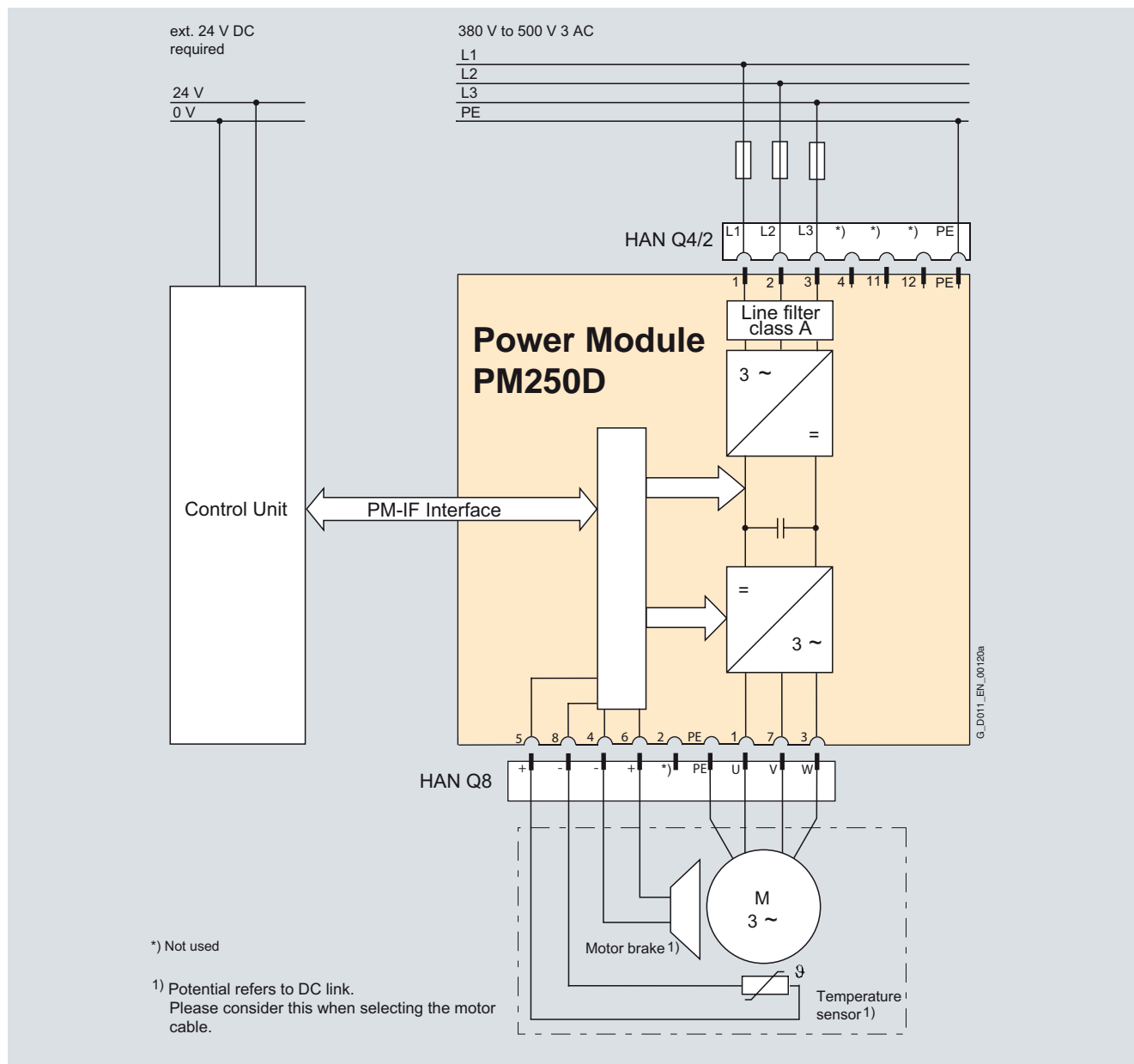

Connection diagram for PM250D Power Module with integrated class A line filter

SINAMICS G120D

Distributed inverters 0.75 kW to 7.5 kW (1.0 hp to 10 hp)

PM250D Power Modules

Technical specifications

General technical specifications

	PM250D Power Modules												
System operating voltage	380 ... 500 V 3 AC $\pm 10\%$												
Line supply requirements	$\leq 1\%$												
Line short circuit voltage u_K													
Input frequency	47 ... 63 Hz												
Output frequency													
• Control type V/f	0 ... 650 Hz												
• Control type Vector	0 ... 200 Hz												
Pulse frequency	4 kHz (standard), higher pulse frequencies up to 16 kHz, see the derating data												
Power factor	0.95												
Inverter efficiency	95 ... 97 %												
Modulation depth	87 %												
Overload capability													
• High overload (HO)	<ul style="list-style-type: none"> • Average maximum rated output current during a cycle time of 300 s • 1.5 × rated output current (i.e. 150 % overload) over 60 s at a cycle time of 300 s • 2 × rated output current (i.e. 200 % overload) over 3 s at a cycle time of 300 s 												
Electromagnetic compatibility	Integrated class A line filter according to EN 55011												
Possible braking methods	Energy recovery in generator mode (max. with rated power possible); Integrated brake control supplies the DC supply voltage for the brake												
	<table border="1"> <thead> <tr> <th>Line voltage</th> <th>380 V AC</th> <th>400 V AC</th> <th>440 V AC</th> <th>480 V AC</th> <th>500 V AC</th> </tr> </thead> <tbody> <tr> <td>Rectified brake voltage</td> <td>171 V DC</td> <td>180 V DC</td> <td>198 V DC</td> <td>216 V DC</td> <td>225 V DC</td> </tr> </tbody> </table>	Line voltage	380 V AC	400 V AC	440 V AC	480 V AC	500 V AC	Rectified brake voltage	171 V DC	180 V DC	198 V DC	216 V DC	225 V DC
Line voltage	380 V AC	400 V AC	440 V AC	480 V AC	500 V AC								
Rectified brake voltage	171 V DC	180 V DC	198 V DC	216 V DC	225 V DC								
	Disconnection on the DC side permits "fast" braking (max. output current 1 A)												
Degree of protection	IP65												
Operating temperature	-10 ... +55 °C (operating temperature ranges of the Control Units should be taken into account)												
Storage temperature	-40 ... +70 °C (-40 ... +158 °F)												
Permissible mounting position	Horizontal wall mounting and mounting in the horizontal position												
Relative humidity	< 95 % RH, condensation not permissible												
Cooling	FSA and FSB: Convection FSC: Air cooling as required using the integrated fan												
Installation altitude	up to 1000 m above sea level without power reduction, > 1000 m see derating characteristics												
Standard SCCR (Short Circuit Current Rating) ¹⁾	10 kA												
Protection functions	<ul style="list-style-type: none"> • Undervoltage • Overvoltage • Overcontrol/overload • Ground fault • Short circuit • Stall protection • Motor blocking protection • Motor overtemperature • Inverter overtemperature • Parameter locking 												
Standards conformance	UL 508C (UL list number E121068), cUL, CE, c-tick												
CE mark	According to Low-Voltage Directive 73/23/EEC and Machinery Directive 98/37/EC												

¹⁾ Applies to industrial control cabinet installations to NEC Article 409/UL 508A. For further information, visit us on the Internet at: <http://support.automation.siemens.com/WW/view/en/23995621>

SINAMICS G120D

Distributed inverters 0.75 kW to 7.5 kW (1.0 hp to 10 hp)

PM250D Power Modules

Technical specifications

Line supply voltage 380 ... 500 V 3 AC	PM250D Power Modules			
	6SL3525-0PE17-5AA0	6SL3525-0PE21-5AA0	6SL3525-0PE23-0AA0	
Rated output current I_{rated} ¹⁾	A	2.2	4.1	7.7
Output current I_{max}	A	4.4	8.2	15.4
Rated power	kW (hp)	0.75 (1.0)	1.5 (1.5) ³⁾	3.0 (4.0)
Rated pulse frequency	kHz	4	4	4
Efficiency η		0.97	0.97	0.97
Power loss	kW	0.047	0.061	0.103
Cooling air requirement	m ³ /s	0.004	0.005	0.009
Sound pressure level L_{pA} (1 m)	dB	–	–	–
Rated input current ²⁾	A	2.1	3.8	7.2
Line supply connection U1/L1, V1/L2, W1/L3, PE		HAN Q4/2 (connector)	HAN Q4/2 (connector)	HAN Q4/2 (connector)
• Conductor cross-section	mm ²	1.5 ... 6	1.5 ... 6	2.5 ... 6
Motor connection U2, V2, W2, PE, motor brake, temperature sensor		HAN Q8 (socket)	HAN Q8 (socket)	HAN Q8 (socket)
• Conductor cross-section	mm ²	1 ... 4	1 ... 4	2.5 ... 4
Motor cable length, max.	m	15	15	15
Degree of protection		IP65	IP65	IP65
Dimensions				
• Width	mm	450	450	450
• Height	mm	210	210	210
• Depth	mm	110	110	180
Frame size		FSA	FSA	FSB
Weight, approx.	kg	5.7	5.7	8

¹⁾ The rated output current I_{rated} is based on the duty cycle for high overload (HO).

²⁾ The input current depends on the motor load and line impedance.
The input currents apply for load at rated power for a line impedance corresponding to $u_K = 1\%$.

³⁾ It is not possible to make any assignment to a particular standard.

SINAMICS G120D

Distributed inverters 0.75 kW to 7.5 kW (1.0 hp to 10 hp)

PM250D Power Modules

Technical specifications

Line supply voltage 380 ... 500 V 3 AC	PM250D Power Modules			
	6SL3525-0PE24-0AA0	6SL3525-0PE25-5AA0	6SL3525-0PE27-5AA0	
Rated output current I_{rated} ¹⁾	A	10.2	13.2	19
Output current I_{max}	A	20.4	26.4	38
Rated power	kW (hp)	4 (5)	5.5 (7.5)	7.5 (10)
Rated pulse frequency	kHz	4	4	4
Efficiency η		0.97	0.97	0.97
Power loss	kW	0.141	0.209	0.295
Cooling air requirement	m ³ /s	0.012	0.018	0.025
Sound pressure level L_{pA} (1 m)	dB	74.5	74.5	74.5
Rated input current ²⁾	A	9.5	12.2	17.7
Line supply connection U1/L1, V1/L2, W1/L3, PE		HAN Q4/2 (connector)	HAN Q4/2 (connector)	HAN Q4/2 (connector)
• Conductor cross-section	mm ²	2.5 ... 6	4 ... 6	4 ... 6
Motor connection U2, V2, W2, PE, motor brake, temperature sensor		HAN Q8 (socket)	HAN Q8 (socket)	HAN Q8 (socket)
• Conductor cross-section	mm ²	2.5 ... 4	4	4
Motor cable length, max.	m	15	15	15
Degree of protection		IP65	IP65	IP65
Dimensions				
• Width	mm	450	450	450
• Height	mm	210	210	210
• Depth	mm	220	220	220
Frame size		FSC	FSC	FSC
Weight, approx.	kg	8.5	8.5	8.5

¹⁾ The rated output current I_{rated} is based on the duty cycle for high overload (HO).

²⁾ The input current depends on the motor load and line impedance. The input currents apply for load at rated power for a line impedance corresponding to $u_k = 1\%$.

SINAMICS G120D

Distributed inverters 0.75 kW to 7.5 kW (1.0 hp to 10 hp)

PM250D Power Modules

Characteristic curves

Derating data

Pulse frequency

Rated power at 400 V 3 AC		Rated output current in A for a pulse frequency of						
kW	hp	4 kHz	6 kHz	8 kHz	10 kHz	12 kHz	14 kHz	16 kHz
0.75	1.0	2.2	1.9	1.5	1.3	1.1	1.0	0.9
1.5	1.5 ¹⁾	4.1	3.5	2.9	2.5	2.1	1.8	1.6
3.0	4.0	7.7	6.5	5.4	4.6	3.9	3.5	3.1
4.0	5.0	10.2	8.7	7.1	6.1	5.1	4.6	4.1
5.5	7.5	13.2	11.2	9.2	7.9	6.6	5.9	5.3
7.5	10	19	16.2	13.3	11.4	9.5	8.6	7.6

Ambient temperature

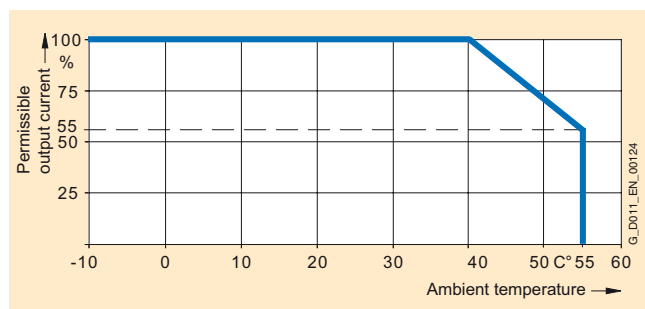

Installation altitude

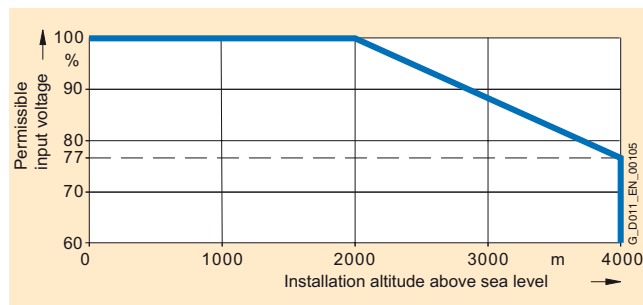
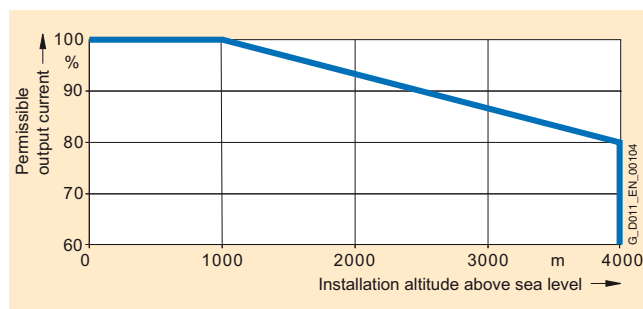

Note: The operating temperature ranges of the Control Units should be taken into account. The temperature ranges are specified in the technical specifications under Control Units.

6

¹⁾ It is not possible to make any assignment to a particular standard.

Dimensional drawings

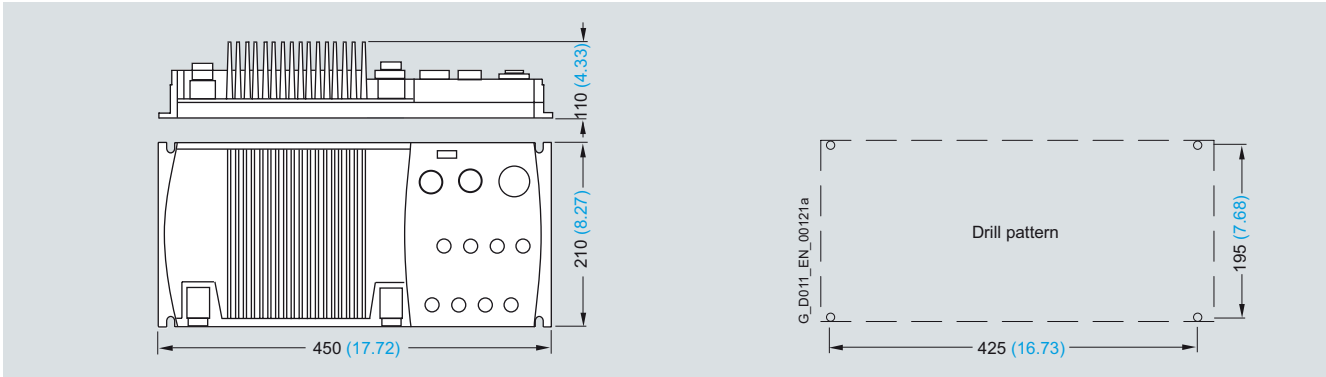

PM250D Power Module frame size FSA with integrated class A line filter and plugged on Control Unit

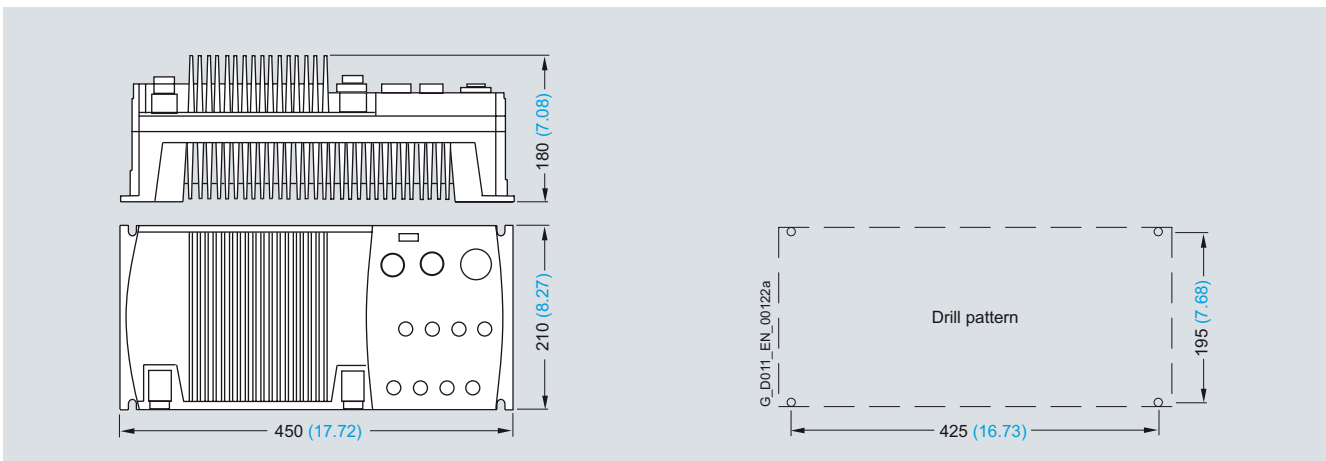

PM250D Power Module frame size FSB with integrated class A line filter and plugged on Control Unit

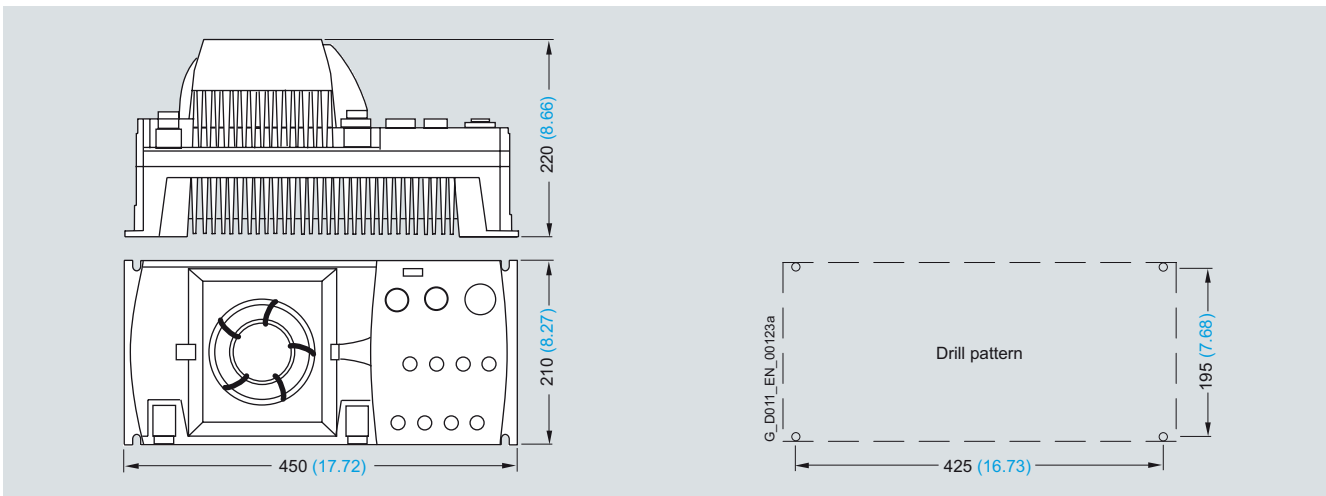

PM250D Power Module frame size FSC with integrated class A line filter and plugged on Control Unit

Mounted using M5 or M6 screwed joints with a maximum washer diameter of 12 mm.

3 mm allen screw for the Control Unit.

Ventilation clearance required (for wall mounting) at top and bottom: 150 mm (5.9 inches).

All dimensions in mm (values in brackets are in inches).

SINAMICS G120D

Distributed inverters 0.75 kW to 7.5 kW (1.0 hp to 10 hp)

Recommended line components

Overview

The following table lists recommendations for additional line-side components, such as fuses and circuit breakers (line-side components dimensioned in accordance with IEC standards). The specified circuit breakers are UL-certified. 3NA3 fuses are recommended for European countries. The values in the table take into account the overload capability of the inverter.

Additional information about the listed fuses and circuit breakers can be found in Catalogs LV 1 and LV 1 T.

Selection and ordering data

For individual protection

Rated power		SINAMICS G120D PM250D Power Modules		Protection	Fuse	Circuit breaker
kW	hp	Type 6SL3525-...	Frame size	A	Order No.	Order No.
380 ... 500 V 3 AC						
0.75	1	OPE17-5AA0	FSA	10	3NA3803	3RV1021-1FA10
1.5	1.5 ¹⁾	OPE21-5AA0	FSA	10	3NA3803	3RV1021-1JA10
3	4	OPE23-0AA0	FSB	26	3NA3805	3RV1021-4AA10
4	5	OPE24-0AA0	FSC	20	3NA3807	3RV1021-4BA10
5.5	7.5	OPE25-5AA0	FSC	20	3NA3807	3RV1031-4EA10
7.5	10	OPE27-5AA0	FSC	32	3NA3812	3RV1031-4FA10

Group protection

The group protection designates those configurations in which a circuit-breaker or a fuse provides protection for two or several devices and their feeder cables. The protective device is known as branch protection (BCP) device.

You will find additional information on the group protection and recommended types in the FAQ:

<http://support.automation.siemens.com/ww/view/en/31560253>

¹⁾ It is not possible to make any assignment to a particular standard.

Accessories

Intelligent Operator Panel IOP Handheld



IOP Handheld for mobile use

The Intelligent Operator Panel IOP Handheld is a very user-friendly and powerful operator panel for commissioning and diagnostics as well as local operator control and monitoring of the SINAMICS G120D distributed inverter.

The IOP supports both entry-level personnel and drive experts. Thanks to the large plain text display, the menu prompting and the Application Wizards, it is easy to commission standard drives. A drive can be essentially commissioned without having to use a printed parameter list as the parameters are displayed in plain text, explanatory help texts are provided and the parameter filtering function.

Application Wizards interactively guide you when commissioning important applications such as conveyor technology, pumps, fans and compressors.

There are Quick Commissioning Wizards for general commissioning.

The drives are manually and simply controlled using directly assigned buttons and the navigation wheel. The IOP Handheld has a dedicated switchover key to switch over from the automatic to the manual mode.

The inverter can be diagnosed in a user-friendly fashion using the plain text display of faults and alarms. Help texts can be obtained by pressing the INFO button.

Up to two process values can either be graphically or numerically visualized on the status screen/status display.

Process values can also be displayed in technological units.

The IOP Handheld supports series commissioning of identical drives. For this purpose, a parameter list can be copied from an inverter into the IOP Handheld and when required, downloaded into other drive units of the same type.

The IOP Handheld includes the following language packages: German, English, French, Italian and Spanish.

In addition to the IOP, the IOP Handheld includes a housing with the rechargeable batteries, charging unit and RS232 interface cable. The charging unit is supplied with connector adapters for Europe, the US and UK. When the batteries are fully charged, the operating time is up to 8 hours.

To connect the IOP Handheld to SINAMICS G120D, in addition, the RS232 interface cable with optical interface is required.

Updating the IOP Handheld

The IOP Handheld can be updated and expanded using the integrated USB interface.

Data to support future drive systems can be dragged from the PC and dropped into the IOP Handheld. Further, the USB interface allows user languages and Wizards that become available in the future to be subsequently downloaded and the firmware updated for the IOP Handheld.

The IOP is supplied with power via the USB interface during an update.

Selection and ordering data

Designation	Order No.
IOP Handheld For use with SINAMICS G120, SINAMICS G110D, SINAMICS G120D, SIMATIC ET 200S FC or SIMATIC ET 200pro FC Included in the scope of delivery: <ul style="list-style-type: none"> • IOP • Handheld housing • Rechargeable batteries (4 × AA) • Charging unit (international) • RS232 connecting cable (3 m long, can only be used for SINAMICS G120 and SIMATIC ET 200S FC) • USB cable (1 m long) 	new 6SL3255-0AA00-4HA0
RS232 interface cable With optical interface to connect the SINAMICS G110D, SINAMICS G120D or SIMATIC ET 200pro FC inverters to the IOP Handheld (2.5 m long)	3RK1922-2BP00

SINAMICS G120D

Distributed inverters 0.75 kW to 7.5 kW (1.0 hp to 10 hp)

Supplementary system components

Accessories

MMC memory card



The parameter settings for an inverter can be stored on the MMC memory card. When service is required, e.g. after the inverter has been replaced and the data have been downloaded from the memory card the drive system is immediately ready for use again.

Selection and ordering data

	Order No.
MMC memory card	6SL3254-0AM00-0AA0

RS232 interface cable for communication with a PC

For controlling and commissioning an inverter directly from a PC over a point-to-point link if the appropriate software (STARTER commissioning tool ¹⁾, from Version 4.1, SP1 and higher) has been installed.

Selection and ordering data

	Order No.
RS232 interface cable for communication with a PC	3RK1922-2BP00

USB interface cable for communication with a PC

For controlling and commissioning an inverter directly from a PC over a point-to-point link if the appropriate software (STARTER commissioning tool ¹⁾, from Version 4.1, SP1 and higher) has been installed.

Selection and ordering data

	Order No.
USB interface cable for communication with a PC (2.5 m long)	new 6SL3555-0PA00-2AA0

STARTER Commissioning Tool

The STARTER commissioning tool (from STARTER Version 4.1, SP1 and higher) supports the commissioning and maintenance of SINAMICSG120D inverters. The operator guidance combined with comprehensive, user-friendly functions for the relevant drive solution allow you to commission the device quickly and easily.

Selection and ordering data

	Order No.
STARTER commissioning tool ¹⁾ on DVD	6SL3072-0AA00-0AG0

¹⁾ The STARTER commissioning tool is also available on the Internet under <http://support.automation.siemens.com/WW/view/en/10804985/133100>

Accessories

Connecting cable for the Control Unit**PROFINET connecting cable**

Flexible plug-in cables and connectors that can be assembled in the field for transmission of data (up to 100 Mbit/s) between Industrial Ethernet participants with IP65 degree of protection.

Selection and ordering data

	Order No.
IE connecting cable M12-180/M12-180	
Pre-fabricated IE FC TP trailing cable GP 2 × 2 PROFINET type C) with two 4-pin M12 connectors (4-pin, D-coded), IP65/IP67 degree of protection Length:	
• 0.3 m	6XV1870-8AE30
• 0.5 m	6XV1870-8AE50
• 1.0 m	6XV1870-8AH10
• 1.5 m	6XV1870-8AH15
• 2.0 m	6XV1870-8AH20
• 3.0 m	6XV1870-8AH30
• 5.0 m	6XV1870-8AH50
• 10 m	6XV1870-8AN10
• 15 m	6XV1870-8AN15
IE M12 Plug PRO	
For assembly in the field, M12 connector (D-coded), metal housing, fast connection method, for SCALANCE X208PRO and IM 154-4 PN	
• 1 unit	6GK1901-0DB10-6AA0
• 8 units	6GK1901-0DB10-6AA8

PROFIBUS connecting cable

Flexible plug-in cables/connectors for transmission of data (up to 12 Mbit/s) from PROFIBUS participants.

Selection and ordering data

	Order No.
PROFIBUS M12 plug-in cable	
Pre-fabricated with two 5-pole M12 connectors/sockets Length:	
• 0.3 m	6XV1830-3DE30
• 0.5 m	6XV1830-3DE50
• 1.0 m	6XV1830-3DH10
• 1.5 m	6XV1830-3DH15
• 2.0 m	6XV1830-3DH20
• 3.0 m	6XV1830-3DH30
• 5.0 m	6XV1830-3DH50
• 10 m	6XV1830-3DN10
• 15 m	6XV1830-3DN15
PROFIBUS M12 connectors	
5-pole, B-coded, metal enclosure, 1 package = 5 units	
• Pin insert	6GK1905-0EA00
• Socket insert	6GK1905-0EB00

Connecting cables/connectors for supplying the Control Unit with power**Selection and ordering data**

	Order No.
7/8" plug-in cable	
For power supply, pre-fabricated with two 5-pole 7/8" plug/socket connectors Length:	
• 0.3 m	6XV1822-5BE30
• 0.5 m	6XV1822-5BE50
• 1.0 m	6XV1822-5BH10
• 1.5 m	6XV1822-5BH15
• 2.0 m	6XV1822-5BH20
• 3.0 m	6XV1822-5BH30
• 5.0 m	6XV1822-5BH50
• 10 m	6XV1822-5BN10
• 15 m	6XV1822-5BN15
7/8"-connector	
5-pole, B-coded, plastic enclosure, 1 package = 5 units	
• Pin insert	6GK1905-0FA00
• Socket insert	6GK1905-0FB00

Connecting cables for digital inputs**Selection and ordering data**

	Order No.
M12 plug-in cable	
With PUR sheath, to connect digital sensors and actuators, pre-fabricated at one end, angled, plug connector, 5-pole, 5 × 0.34 mm ² length:	
• 1.5 m	new 3RX8000-1CE52-1AB5
• 5 m	new 3RX8000-1CE52-1AF0
• 10 m	new 3RX8000-1CE52-1AL0

SINAMICS G120D

Distributed inverters 0.75 kW to 7.5 kW (1.0 hp to 10 hp)

Supplementary system components

Accessories

Connecting cables for Power Modules

Connecting cables pre-fabricated at one end and connector sets to connect to the line supply

Selection and ordering data

	Order No.
Connecting cable pre-fabricated at one end	
Power supply cable, open at one end, for HAN Q4/2, angled, 4 × 4 mm ²	
• 1.5 m long	3RK1911-0DB13
• 5 m long	3RK1911-0DB33
Connector set for the power supply	
HAN Q4/2	
• 2.5 mm ²	3RK1911-2BE50
• 4 mm ²	3RK1911-2BE10
• 6 mm ²	3RK1911-2BE30

Motor cables pre-fabricated at one end and connector sets to connect the Power Module to the motor

Selection and ordering data

Motor cables pre-fabricated at one end	Order No.			
	(HTG: supplied from the Harting Company) (ZKT: supplied from the KnorrTec Company)			
Cross-section	1 mm ²	1.5 mm ²	2.5 mm ²	4 mm ²
• 1.5 m long	new ZKT: 70018601000150	HTG: 61 88 201 0288	new HTG: 61 88 201 0291	HTG: 61 88 201 0303
• 3 m long	new ZKT: 70018601000300	HTG: 61 88 201 0289	new HTG: 61 88 201 0292	HTG: 61 88 201 0304
• 5 m long	new ZKT: 70018601000500	HTG: 61 88 201 0290	new HTG: 61 88 201 0293	HTG: 61 88 201 0305
• 10 m long	new ZKT: 70018601001000	HTG: 61 88 201 0299	new HTG: 61 88 201 0301	HTG: 61 88 201 0306
			new ZKT: 70009601001000	new ZKT: 70017001001000
Connector set for motor cables	Order No.			
Shielded, HAN Q8				
• up to 1.5 mm ²	–	6ES7194-1AB01-0XA0	–	–
Connector set for motor cables	Order No.			
Shielded, HAN Q8	(HTG: supplied from the Harting Company) (ZKT: supplied from the KnorrTec Company)			
• up to 2.5 mm ²	–	–	new HTG: 61 83 401 0132	–
			new ZKT: 10032011	
• up to 4 mm ²	–	–	–	new HTG: 61 83 401 0133
				new ZKT: 10032021

Accessories*Power bus distribution 400 V in IP65 degree of protection*

	Ordering (see Solution Partner)
Power T clamp connector for 2.5 ... 6 mm² With attached 7-pole connector, socket insert, grommet housing, UL Seals for various cable cross-sections must be separately ordered	Ordered and supplied from the Harting Company
T clamp connector Completely pre-fabricated	Ordered and supplied from the KnorrTec Company
T distributor box, IDC connection, power cable Uncut power cable, 2.5 ... 6 mm ² , 2 outgoing feeders: Push-in connection: 1.5 ... 6 mm ² Seals for various cable cross-sections must be separately ordered	Ordered and supplied from the Weidmüller Company
T distributor box Completely pre-fabricated	Ordered and supplied from the KnorrTec Company

Additional information

For further information about the connecting cables and plug-in connectors mentioned above, please refer to Catalog IK PI.

Further selected accessories are available from Siemens Solution Partners. Select "Distributed Field Installation System" as technology in the "SolutionPartner Finder".

<http://www.siemens.com/automation/partnerfinder>



SINAMICS G120D

Distributed inverters 0.75 kW to 7.5 kW (1.0 hp to 10 hp)

Spare parts Spare Parts Kit

Spare parts Replacement fan

Overview

A Spare Parts Kit can be ordered which comprises small parts such as replacement seals, caps, PROFIBUS address windows and screws.

Selection and ordering data

	Order No.
Spare Parts Kit for SINAMICS G120D comprising replacement seals, caps, PROFIBUS address windows and screws	6SL3500-0SK01-0AA0

Overview

The Power Module fans are designed for extra long service life. Replacement fans can be ordered for special applications.

Selection and ordering data

Rated power		SINAMICS G120D PM250D Power Module		Replacement fan	
kW	hp	Type	Frame size	Order No.	
380 ... 500 V 3 AC					
4.0	5.0	OPE24-0AA0	FSC	6SL3500-0SF01-0AA0	
5.5	7.5	OPE25-5AA0		(pre-mounted unit with cover, fan and screws)	
7.5	10	OPE27-5AA0			